

Technical data sheet



Product features

Open stand mobile

Model

SAP Code

00003162



– Material: Stainless steel

Technical data sheet



Technical drawing

Open stand mobile

Model

SAP Code

00003162

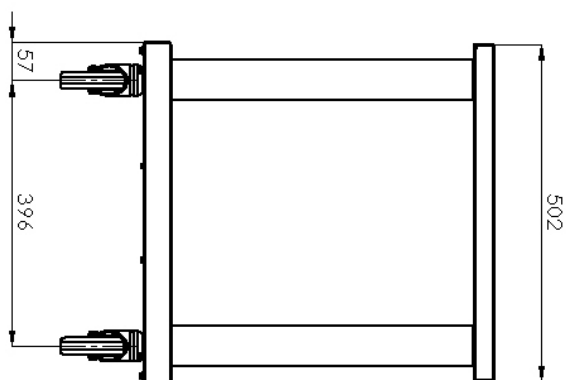
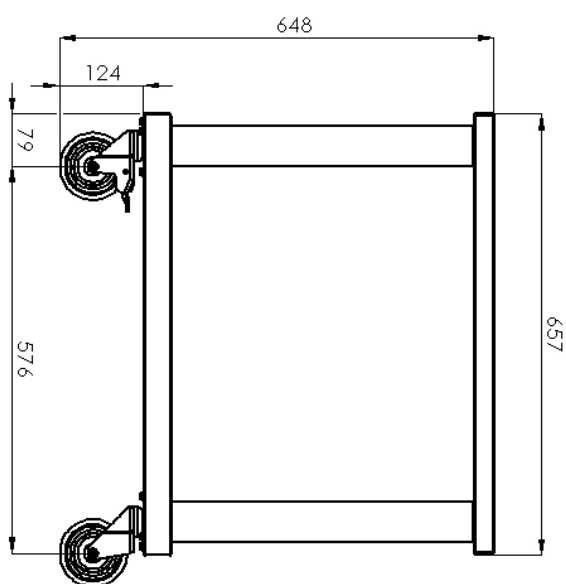

Technical data sheet



Technical parameters

Open stand mobile

Model

SAP Code

00003162

1. SAP Code:

00003162

2. Net Width [mm]:

657

3. Net Depth [mm]:

502

4. Net Height [mm]:

648

5. Net Weight [kg]:

20.50

6. Gross Width [mm]:

670

7. Gross depth [mm]:

520

8. Gross Height [mm]:

660

9. Gross Weight [kg]:

21.00

10. Material:

Stainless steel

11. Adjustable feet:

No

12. Construction type of device 3:

Opened

13. Device properties:

Neutral

14. Construction type of device:

On wheels

15. Unit:

No